

Featherlite[®]



AMAZE HB

- ▶ **WARRANTY CARD** (Register Now)
- ▶ **ASSEMBLY INSTRUCTIONS**
- ▶ **USER MANUAL**

PARTS



① Chair Back (1x)



② Seat with Arms (1x)



③ Gas Lift (1x)



④ Base (1x)



⑤ Headrest



⑥ M8x40 (3x)



⑦ M6x20 (2x)

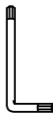

⑩ Allen Key M8



⑧ M8 Cut Washer (3x)



⑨ M8x2 Plain Washer (3x)



⑪ Allen Key M6

STEP 1

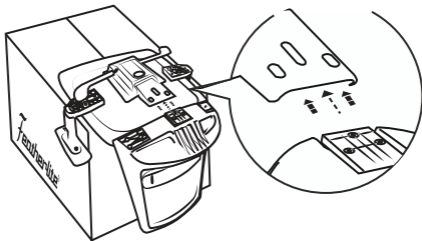

Fix Chair Back to
Mechanism Seat

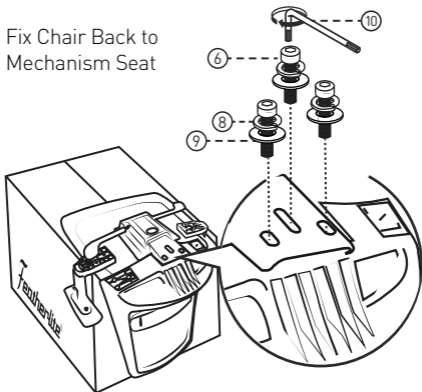

STEP 2

Fix Headrest

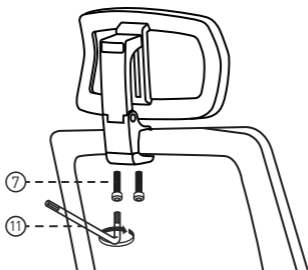

STEP 3

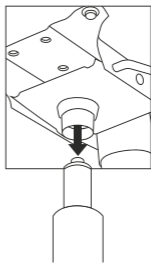
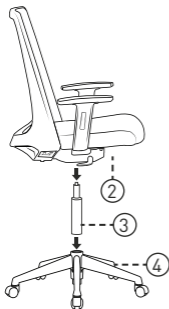

Fix Gas-Lift and Base

USER MANUAL



Adjustable arms
with soft PU padding

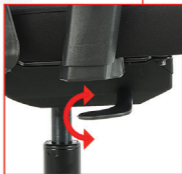

Seat height
adjustment Lever

USER MANUAL

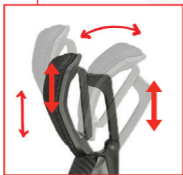

Adjustable
Headrest

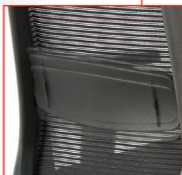

Adjustable
Lumbar Support

USER MANUAL



Recline Lock Lever for
Multi-Lock Adjustment



ACTIVATE YOUR
3 YEAR
WARRANTY NOW



Register within 7 days after receiving
the product to validate warranty

Scan the below QR code to register



OR

www.featherlitestore.com/register

Use the code **LOYAL** to get a 7.5% discount on
your next purchase on the official website.

 **080-4719-1010**